

60V N-Ch Power MOSFET

Feature

- ◇ High Speed Power Switching
- ◇ Enhanced Body diode dv/dt capability
- ◇ Enhanced Avalanche Ruggedness
- ◇ 100% UIS Tested, 100% Rg Tested
- ◇ Lead Free

Application

- ◇ Synchronous Rectification in SMPS
- ◇ Hard Switching and High Speed Circuit
- ◇ Power Tools
- ◇ UPS
- ◇ Motor Control

V_{DS}		60	V
$R_{DS(on),typ}$	TO-220F	1.9	mΩ
I_D (Silicon Limited)		109	A

TO-220F

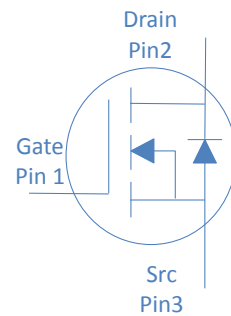

Part Number	Package	Marking
HGA025N06S	TO-220F	GA025N06S

Absolute Maximum Ratings at $T_j=25^\circ\text{C}$ (unless otherwise specified)

Parameter	Symbol	Conditions	Value	Unit
Continuous Drain Current (Silicon Limited)	I_D	$T_C=25^\circ\text{C}$	109	A
		$T_C=100^\circ\text{C}$	77	
Drain to Source Voltage	V_{DS}	-	60	V
Gate to Source Voltage	V_{GS}	-	± 20	V
Pulsed Drain Current	I_{DM}	-	500	A
Avalanche Energy, Single Pulse	E_{AS}	$L=0.1\text{mH}, T_C=25^\circ\text{C}$	180	mJ
Power Dissipation	P_D	$T_C=25^\circ\text{C}$	54	W
Operating and Storage Temperature	T_J, T_{stg}	-	-55 to 175	$^\circ\text{C}$

Absolute Maximum Ratings

Parameter	Symbol	Max	Unit
Thermal Resistance Junction-Case	$R_{\theta JC}$	2.8	$^\circ\text{C/W}$
Thermal Resistance Junction-Ambient	$R_{\theta JA}$	60	$^\circ\text{C/W}$

Electrical Characteristics at $T_j=25^\circ\text{C}$ (unless otherwise specified)

Static Characteristics

Parameter	Symbol	Conditions	Value			Unit
			min	typ	max	
Drain to Source Breakdown Voltage	$V_{(BR)DSS}$	$V_{GS}=0V, I_D=250\mu A$	60	-	-	V
Gate Threshold Voltage	$V_{GS(th)}$	$V_{GS}=V_{DS}, I_D=250\mu A$	2	2.8	4	
Zero Gate Voltage Drain Current	I_{DSS}	$V_{GS}=0V, V_{DS}=60V, T_j=25^\circ\text{C}$	-	-	1	μA
		$V_{GS}=0V, V_{DS}=60V, T_j=100^\circ\text{C}$	-	-	100	
Gate to Source Leakage Current	I_{GSS}	$V_{GS}=\pm 20V, V_{DS}=0V$	-	-	± 100	nA
Drain to Source on Resistance	$R_{DS(on)}$	$V_{GS}=10V, I_D=20A$	-	1.9	2.5	$m\Omega$
Transconductance	g_{fs}	$V_{DS}=5V, I_D=20A$	-	80	-	S
Gate Resistance	R_G	$V_{GS}=0V, V_{DS}$ Open, $f=1\text{MHz}$	-	0.7	-	Ω

Dynamic Characteristics

Input Capacitance	C_{iss}	$V_{GS}=0V, V_{DS}=30V, f=1\text{MHz}$	-	7070	-	pF
Output Capacitance	C_{oss}		-	2140	-	
Reverse Transfer Capacitance	C_{rss}		-	63	-	
Total Gate Charge	Q_g	$V_{DD}=30V, I_D=20A, V_{GS}=10V$	-	85	-	nC
Gate to Source Charge	Q_{gs}		-	24	-	
Gate to Drain (Miller) Charge	Q_{gd}		-	14	-	
Turn on Delay Time	$t_{d(on)}$	$V_{DD}=30V, I_D=20A, V_{GS}=10V, R_G=10\Omega,$	-	36	-	ns
Rise time	t_r		-	62	-	
Turn off Delay Time	$t_{d(off)}$		-	95	-	
Fall Time	t_f		-	34	-	

Reverse Diode Characteristics

Diode Forward Voltage	V_{SD}	$V_{GS}=0V, I_F=20A$	-	0.8	1.2	V
Reverse Recovery Time	t_{rr}	$V_R=30V, I_F=30A, dI_F/dt=300A/\mu s$	-	58	-	ns
Reverse Recovery Charge	Q_{rr}		-	174	-	nC

Fig 1. Typical Output Characteristics

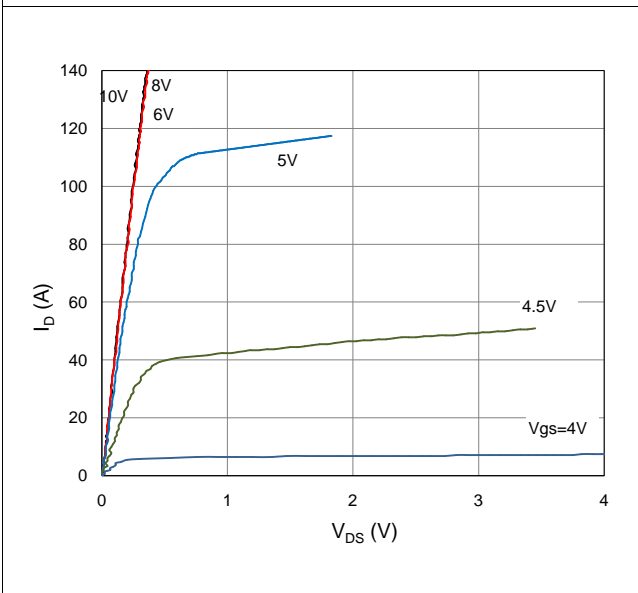

Figure 2. On-Resistance vs. Gate-Source Voltage

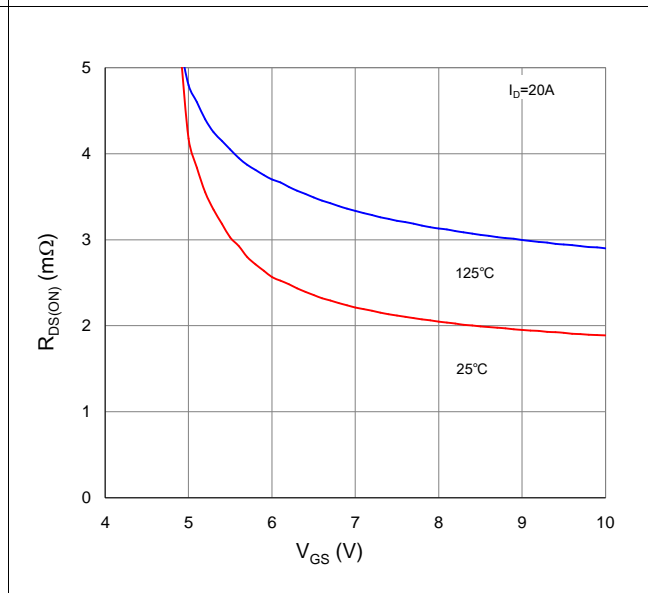

Figure 3. On-Resistance vs. Drain Current and Gate Voltage

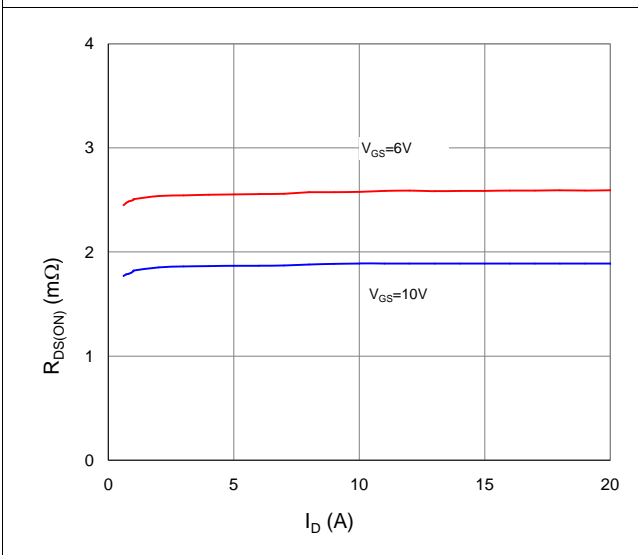

Figure 4. Normalized On-Resistance vs. Junction Temperature

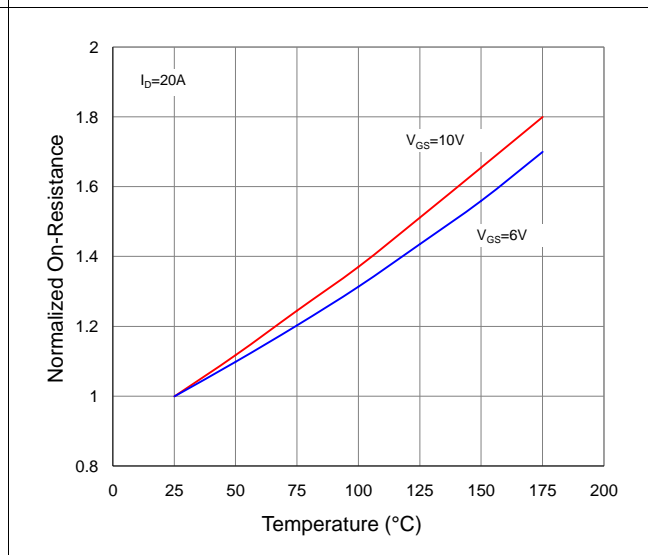

Figure 5. Typical Transfer Characteristics

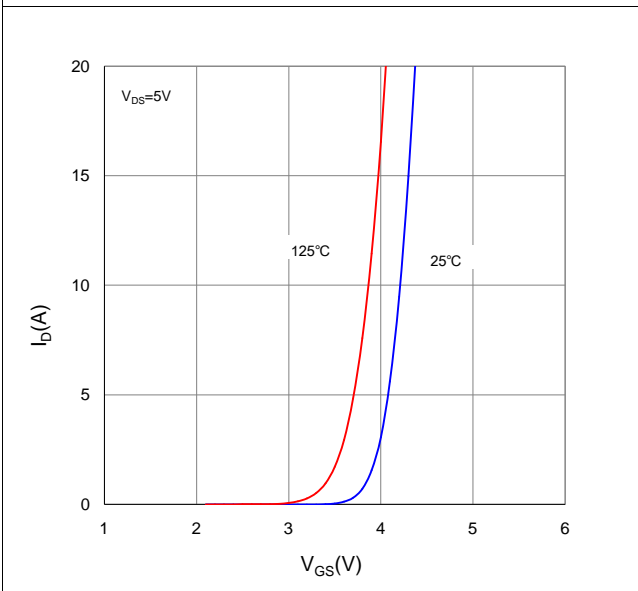

Figure 6. Typical Source-Drain Diode Forward Voltage

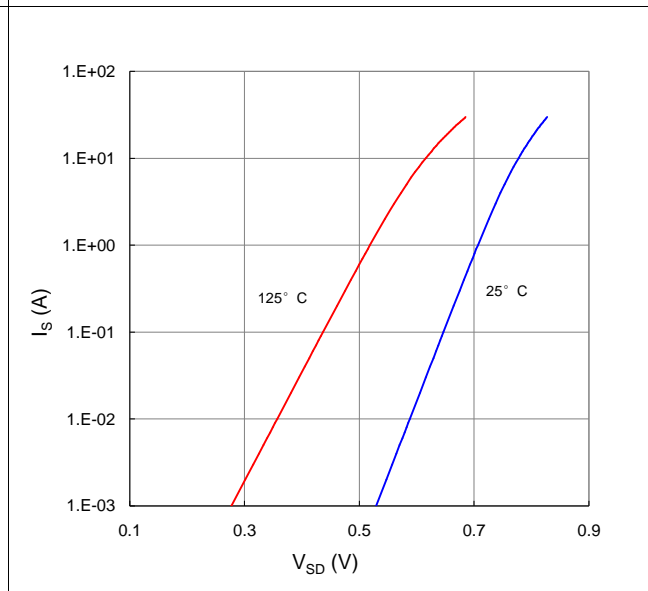

Figure 7. Typical Gate-Charge vs. Gate-to-Source Voltage

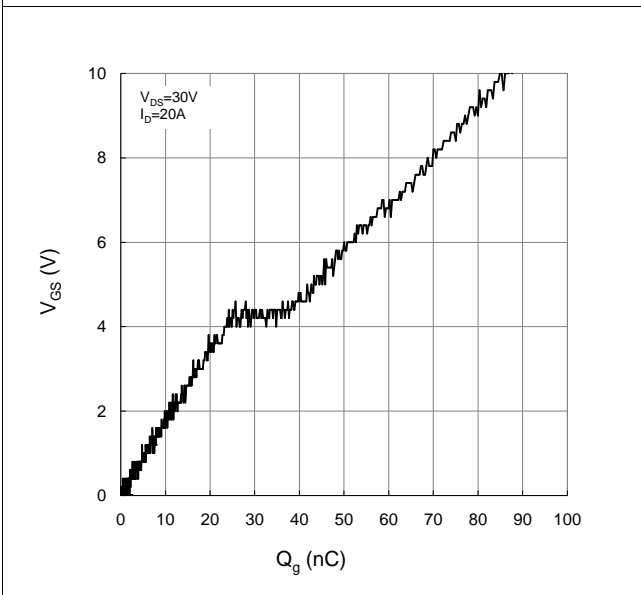

Figure 8. Typical Capacitance vs. Drain-to-Source Voltage

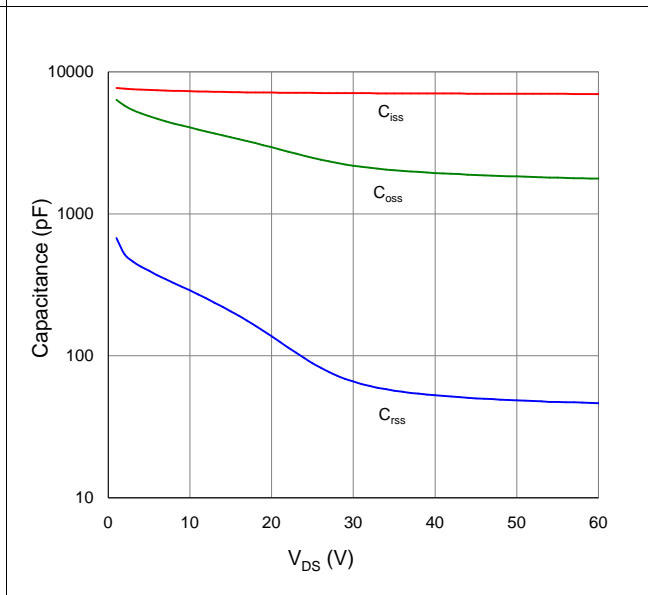

Figure 9. Maximum Safe Operating Area

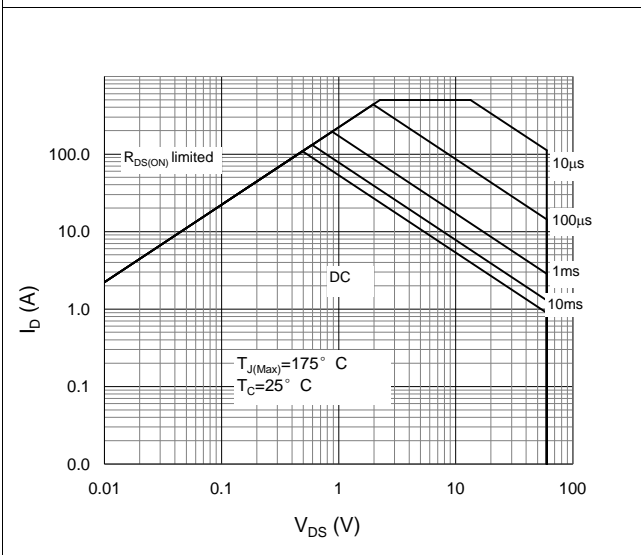

Figure 10. Maximum Drain Current vs. Case Temperature

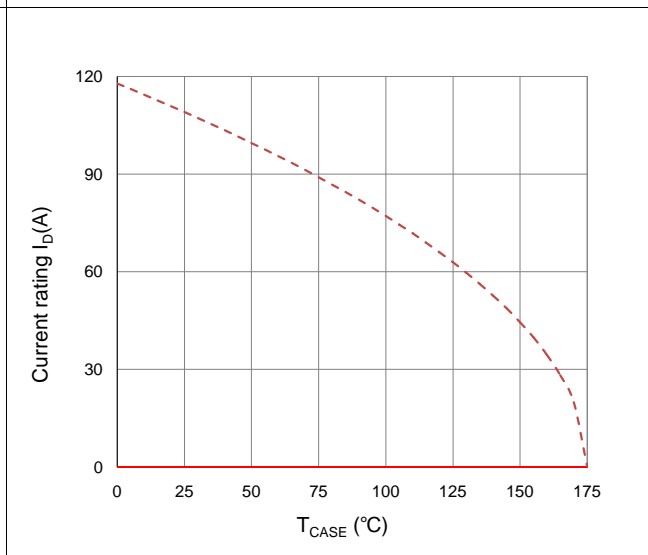
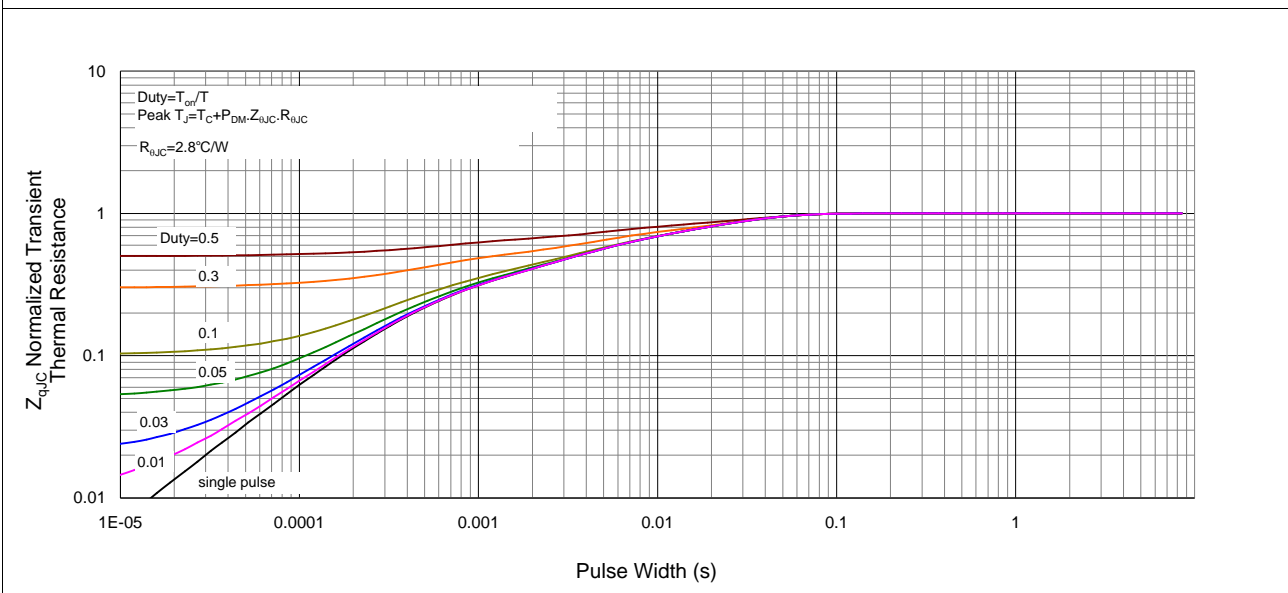
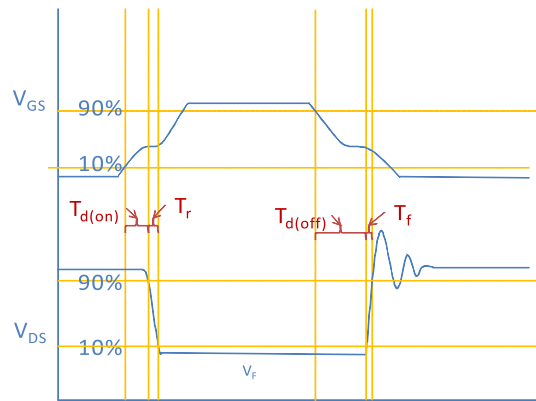

Figure 11. Normalized Maximum Transient Thermal Impedance, Junction-to-Case



Inductive switching Test



Gate Charge Test

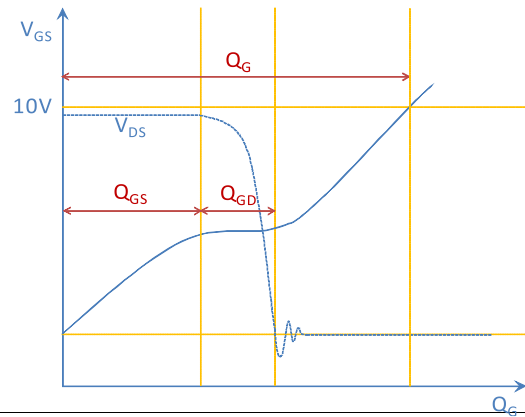

Uclamped Inductive Switching (UIS) Test

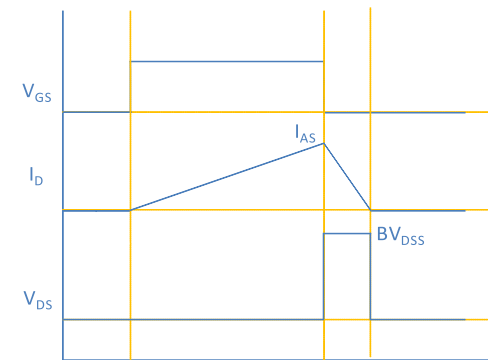

Diode Recovery Test

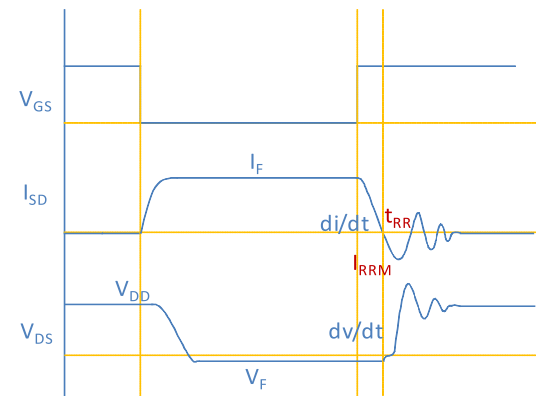
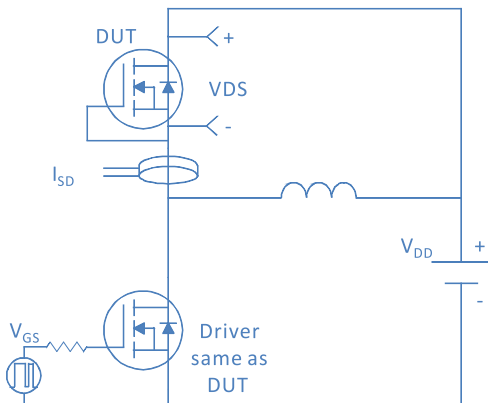

Package Outline

TO-220F, 3 leads

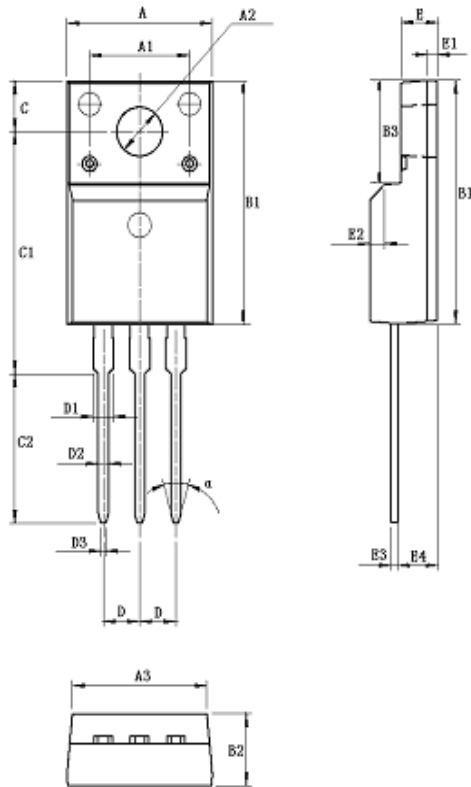

Dimensions in mm unless otherwise specified

Symbol	Min	Nom	Max
A	9.96	10.16	10.36
A1		7	
A2	3.08	3.18	3.28
A3	9.26	9.46	9.66
B1	15.67	15.87	16.07
B2	4.50	4.70	4.90
B3	6.48	6.68	6.88
C	3.20	3.30	3.40
C1	15.60	15.80	16.00
C2	9.55	9.75	9.95
D		2.54	
D1			1.47
D2	0.70	0.80	0.90
D3	0.25	0.35	0.45
E	2.34	2.54	2.74
E1		0.70	
E2	1.0x45°		
E3	0.45	0.50	0.60
E4	2.56	2.76	2.96
α (degree)		30°	